



**Traffic Safety Corporation**  
 2708 47th Ave.  
 Sacramento, CA 95822-3806  
 Toll Free: 888.446.9255  
 Tel: 916.394.9884  
 Fax: 916.394.2809  
 Email: sales@xwalk.com  
 Web: www.xwalk.com

## TS-SR-45 Uni-directional, Stainless Steel LED Road Stud

### General Description

Our TS-SR-45 stainless steel road stud features a durable, low maintenance design with outstanding visibility during the day and at night.

The TS-SR-45 is typically used in crosswalk applications, but it also can be used to mark school zones and rail-road crossings, lane control for bridges and tunnels, wrong way warning, and toll booth or toll way lead-on applications.

All In-Roadway Warning Lighting System components are available from TSC. A typical installation would include a set of road studs, a control system, one or more activation devices such as a pedestrian push button station, and flashing LED crossing signs.

### Features

- Robust construction, suitable for harsh conditions.
- Snowplow resistant.
- Outstanding visibility during the day and at night.
- Suitable for applications in crosswalks, school zones, bridges and tunnels.
- Only .34" (8.7mm) above road surface.
- Connect multiple road studs in series circuit.
- Low maintenance, 100% waterproof.
- Easy replacement: base (fixed in the pavement), main body (removable).
- LEDs protected by polycarbonate window.
- Up to .62 mile (1 km) visibility distance due to high intensity LEDs.
- Optional: use different LED colors in each window.

### Specifications

#### Modes of Operation:

- Always On (other modes of operation like flashing or sequential are available with external controller)

#### LED Configuration:

- Unidirectional

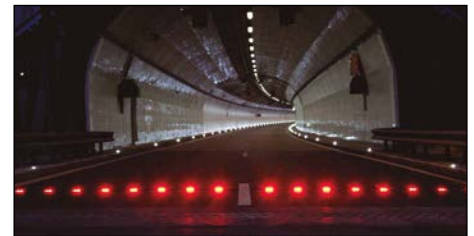

### Electrical:

Power Supply	12V DC or 24V DC	42V AC or 18V~72V DC	120V AC or 230V AC
Current Consumption	80 mA <sup>1</sup>	49 mA <sup>1</sup>	30 mA <sup>1</sup>
Power Cable	Brown Wire (+) Blue Wire (-)	Brown Wire (Line) Blue Wire (Neutral) Yellow/Green (Earth)	Brown Wire (Line) Blue Wire (Neutral) Yellow/Green (Earth)
Working Temperature	-13°F to +185°F (-25°C to +85°C)		

<sup>1</sup> Maximum power consumption.

### Optical:

- LED Number: 8 LEDs
- LED Type: 5mm
- LED Colors: White, Red, Yellow, Green, Blue
- Viewing Angle: 15°

### Mechanical:

- Main Body: Stainless Steel League
- Base: Aluminium
- Mechanical Resistance: 120 tons
- Weight: 6.6 lb. (3 kg)
- Protection Index: IP68, IK10
- Dimensions: 6.32" (160.5mm) diameter x 3.96" (100.7mm) height

### Other Versions

#### TS-SR-45P:

- 4 high power LEDs (1W) for maximum brightness (day and night)
- Specially developed heat sink to increase LED lifetime.
- Viewing Angle: 16°
- Power Supply: 24V DC (200 mA max)

#### TS-SR-45A:

- Material: Aluminum and Polycarbonate
- Mechanical Resistance: 30 tons
- Weight: 4.4 lb. (2 kg)
- Dimensions: 6.32" (160.5mm) diameter x 3.9" (99.3mm) height
- Projection (above road surface): .29" (7.3mm)

#### TS-SR-45AP:

- Material: Aluminum and Polycarbonate
- Mechanical Resistance: 30 tons
- Weight: 4.4 lb. (2 kg)
- Dimensions: 6.32" (160.5mm) diameter x 3.9" (99.3mm) height
- Projection (above road surface): .29" (7.3mm)
- 4 high power LEDs (1W) for maximum brightness (day and night)
- Specially developed heat sink to increase LED lifetime.
- Viewing Angle: 16°
- Power Supply: 24V DC (200 mA max)

**Visit our web site: [www.xwalk.com](http://www.xwalk.com)**



Traffic Safety Corporation  
2708 47th Ave.  
Sacramento, CA 95822-3806  
Toll Free: 888.446.9255  
Tel: 916.394.9884  
Fax: 916.394.2809  
Email: sales@xwalk.com  
Web: www.xwalk.com

## TS-SR-45 Uni-directional, Stainless Steel LED Road Stud

Dimensions (mm)

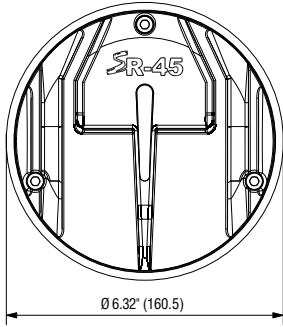

SR-SFT4 Installation Accessory (mm)

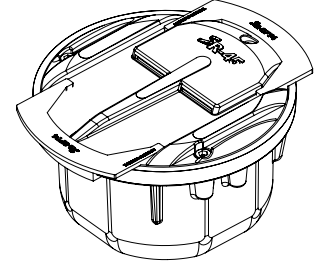
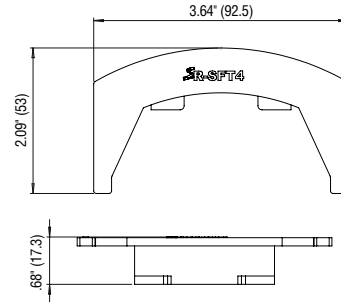
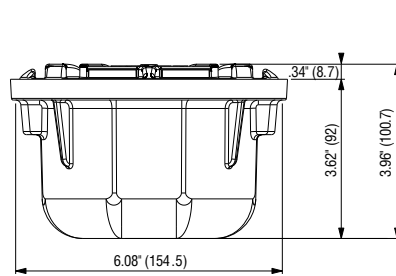

### Installation Procedure



Personal protective equipment must be worn during installation process.

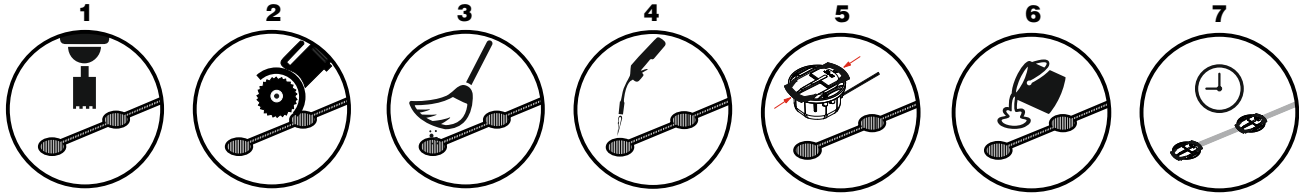

- 1 After deciding the location where the stud will be installed, drill a hole having a minimum diameter of 6.5" (165mm) and 3.94" (100mm) deep.
- 2 Using a disk cutter, open a connection between the holes with .59" (15mm) width and 2.36" (60mm) depth.
- 3 Brush any debris or dust from the hole resulting from drilling.
- 4 Dry the hole with a blowtorch to remove any moisture that may compromise the adhesion and effectiveness of the grout.
- 5 Add a SR-SFT4 installation accessory to each stud. The accessory will help to align and keep the road stud in place during the grout drying time. This accessory will be removed at the end of the installation.
- 6 Pour  $\pm 5.5$  lb. ( $\pm 2.5$  kg) of ULTRAFLOW 4000/8 grout in the hole and insert the stud checking that the LEDs are facing the correct direction. Remove any excess grout.
- 7 The grout drying time may change depending on weather conditions. Consult the grout data sheet for more information. After the grout has dried, the top part of the SR-SFT4 accessory should be broken and removed.

Changing or not completing the described installation process can result in suspension of warranty.

Visit our web site: [www.xwalk.com](http://www.xwalk.com)



Traffic Safety Corporation  
 2708 47th Ave.  
 Sacramento, CA 95822-3806  
 Toll Free: 888.446.9255  
 Tel: 916.394.9884  
 Fax: 916.394.2809  
 Email: sales@xwalk.com  
 Web: www.xwalk.com

## TS-SR-45 Uni-directional, Stainless Steel LED Road Stud

TS-SR-45	<b>Unidirectional 8 LEDs</b>	<i>Description</i>	<i>Color</i>
	<b>Model</b> TS-SR-45-WW-1G TS-SR-45-RR-1G TS-SR-45-YY-1G TS-SR-45-BB-1G TS-SR-45-GG-1G	Hardwired Road Stud / 3mt Cable Inc. / 8 LED / Snowplow Resist. / 1 Cable Gland " " " "	White / White Red / Red Yellow / Yellow Blue / Blue Green / Green

TS-SR-45A	<b>Unidirectional 8 LEDs</b>	<i>Description</i>	<i>Color</i>
	<b>Model</b> TS-SR-45A-WW-1G TS-SR-45A-RR-1G TS-SR-45A-YY-1G TS-SR-45A-BB-1G TS-SR-45A-GG-1G	Hardwired Road Stud / 3mt Cable Inc. / 8 LED / 100% Aluminum / 1 Cable Gland " " " "	White / White Red / Red Yellow / Yellow Blue / Blue Green / Green

**OBS.:** Cable standard (included): 0.75mm<sup>2</sup> wire section  
**Different cable layouts and length should be requested upon order!**  
 Standard mode: Always ON. For flashing or sequential mode, a microcontroller is required.

**Cable Gland:** TS-SR-XX(X)-X(X)-2G 2 Cable Glands

Color (TS-SR-45(A)48) e.g.: TS-SR-XX(X)-WR-XX  
 Color combinations:

Side 1 - White / Side 2 - Red

WR, WY, WB, WG, RY, RB, RG, YB, YG, BG

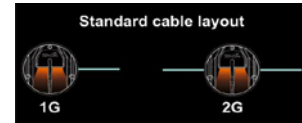

TS-SR-45P	<b>Unidirectional 4 POWER LEDs</b>	<i>Description</i>	<i>Color</i>
	<b>Models</b> TS-SR-45P-WW-1G TS-SR-45P-RR-1G TS-SR-45P-YY-1G TS-SR-45P-BB-1G TS-SR-45P-GG-1G	Hardwired Road Stud / 3mt Cable Inc. / 4 LED / Snowplow Resist. / 1 Cable Gland " " " "	White / White Red / Red Yellow / Yellow Blue / Blue Green / Green

TS-SR-45AP	<b>Unidirectional 4 POWER LEDs</b>	<i>Description</i>	<i>Color</i>
	<b>Models</b> TS-SR-45AP-WW-1G TS-SR-45AP-RR-1G TS-SR-45AP-YY-1G TS-SR-45AP-BB-1G TS-SR-45AP-GG-1G	Hardwired Road Stud / 3mt Cable Inc. / 4 LED / 100% Aluminum / 1 Cable Gland " " " "	White / White Red / Red Yellow / Yellow Blue / Blue Green / Green

**OBS.:** Cable standard (included): 0.75mm<sup>2</sup> wire section  
**Different cable layouts and length should be requested upon order!**  
 Standard mode: Always ON. For flashing or sequential mode, a microcontroller is required.

**Cable Gland:** TS-SR-XX(X)P-X(X)-2G 2 Cable Glands

Color (TS-SR-45(A)48) e.g.: TS-SR-XX(X)P-WR-XX  
 Color combinations:

Side 1 - White / Side 2 - Red

WR, WY, WB, WG, RY, RB, RG, YB, YG, BG

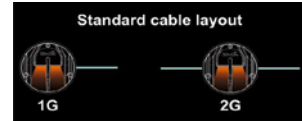

### LED Configuration

One road stud with two or more LED colors

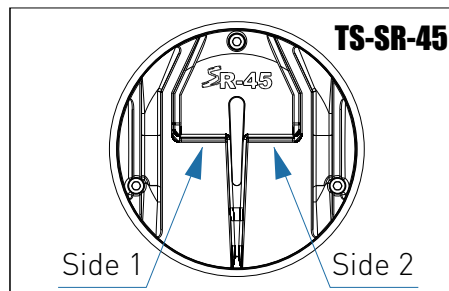

Visit our web site: [www.xwalk.com](http://www.xwalk.com)

# TS-SR-45 Cable Layout

